

PLANTA BAIXA ALAMBRADO  
ESC. 1:100

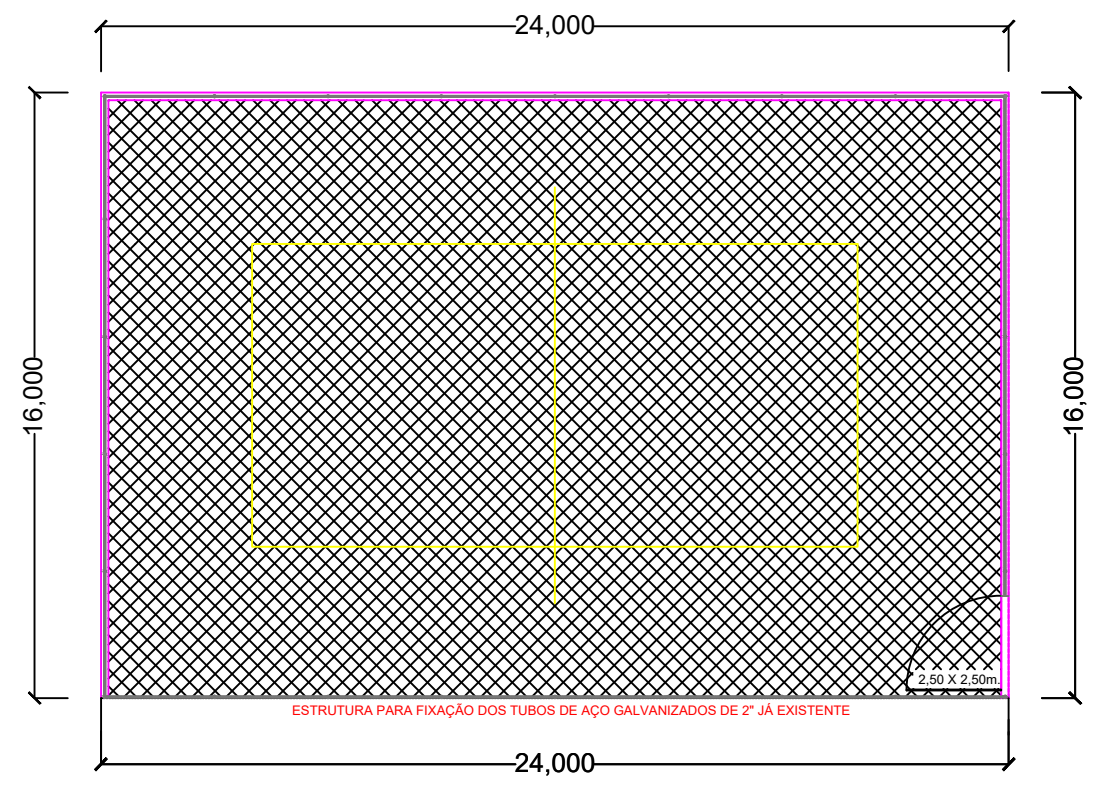

PLANTA BAIXA REDE DE NYLON PARA COBERTURA  
ESC. 1:100

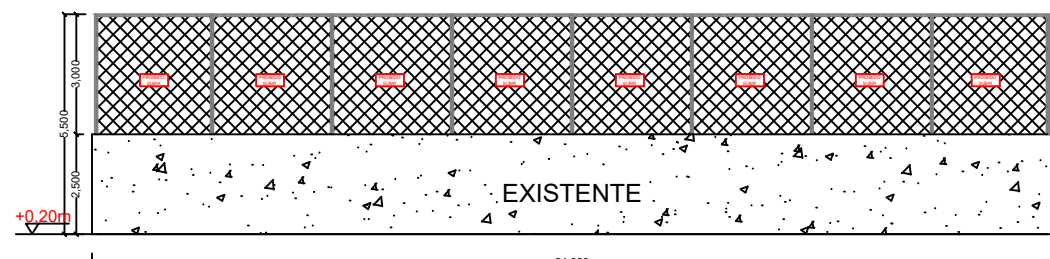

VISTA 01  
ESC. 1:100

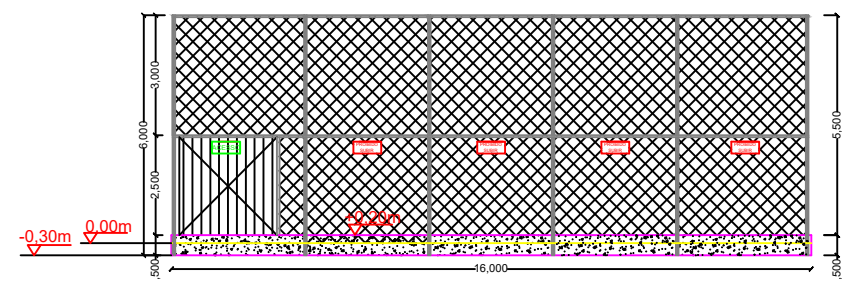

VISTA 04  
ESC. 1:100

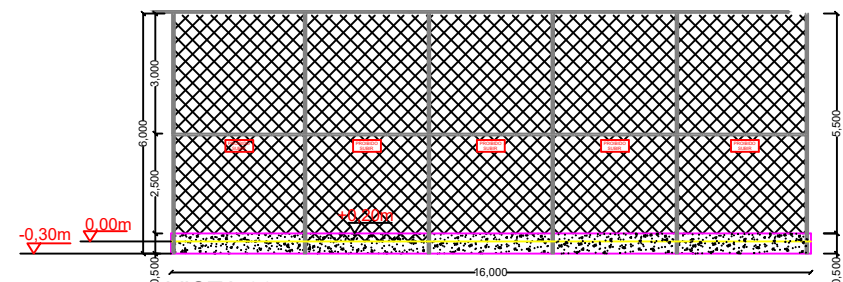
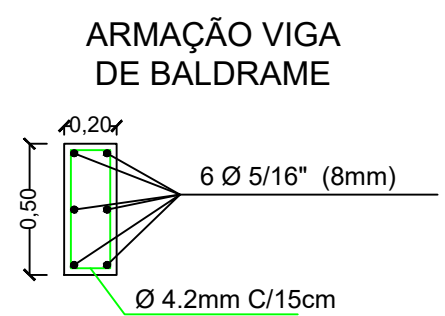
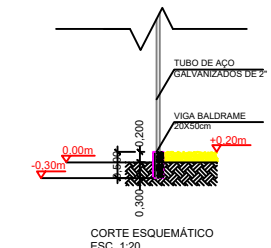

VISTA 02  
ESC. 1:100

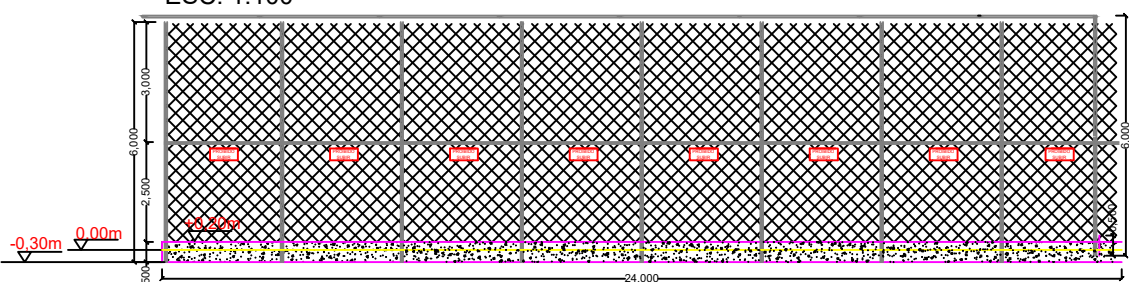

VISTA 03  
ESC. 1:100

- PROIBIDO SUBIR PLACA DE ADVERTÊNCIA 70cmX50cm
- ACESSO PLACA SINALIZAÇÃO 70cmX50cm

|               |  |  |   |
|---------------|--|--|---|
| Obra / Local: |  | <b>Cercamento da Quadra de Areia - Praça da Gruta</b><br>Av. Irmãs Consolata, Paulo Bento/RS |   |
| Data:         | Outubro/2024   | Referência:  | <b>PROJETO ARQUITETÔNICO</b>  |
| Escala:       | Indicada   | Prancha:   | <b>01/01</b>  |
| Proprietário: | _____<br>PROPRIETÁRIO<br>Prefeitura Municipal de Paulo Bento |  | Resp. Técnico:  |
|               |  |  | _____<br>RESPONSÁVEL TÉCNICO<br>Eng <sup>o</sup> Civil Tainã Zanella Abrão CREA/RS 237784 |